

Gen-Eye™ Hot Spot™

Operator's Manual



Issue 1.0

053-2672

ORIGINAL INSTRUCTION

Overview

Chapter Contents

Serial Number Location 2

System Components 2

Intended Use 3

IEC Safety Definitions 3

FCC Statement 4

About This Manual 5

- **Bulleted Lists** 5
- **Numbered Lists** 5

Serial Number Location

Record serial numbers and date of purchase in spaces provided. Unit serial number is located as shown.

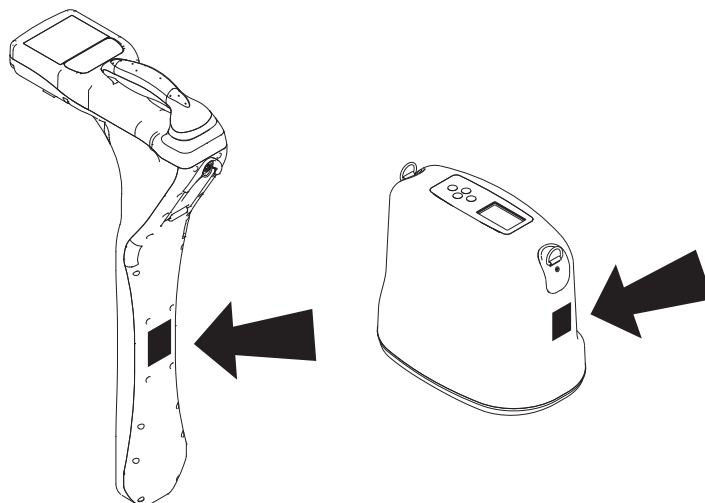

e18om029h.eps

Item	
date of purchase:	
receiver serial number:	
transmitter serial number:	
fault finder serial number:	
accessory model & serial number:	
accessory model & serial number:	

System Components

Receiver (RX): Gen-Eye Hot Spot receiver with 10 frequencies: 512B kHz, 1 kHz, 8 kHz, 33 kHz, 33B kHz, 50 kHz, 60 kHz, 65 kHz, 150 kHz, 180 kHz.

Transmitter (TX): Gen-Eye Hot Spot transmitter with 5-watt power output, 4 frequencies: 1 kHz, 8 kHz, 33 kHz, 65 kHz.

Intended Use

The Gen-Eye Hot Spot receiver is designed to locate buried pipes and cables. Twelve frequencies and four modes of operation are available to suit your specific locating needs.

The Gen-Eye Hot Spot transmitter places a signal on target cables to be detected by Gen-Eye Hot Spot receiver. The signal is placed through either direct connection, induction clamping, or broadcast mode.

The system is designed for operation in temperatures typically experienced in earth moving and construction work environments. Use in any other way is considered contrary to the intended use. The Gen-Eye Hot Spot system should be operated only by persons familiar with its particular characteristics and acquainted with the relevant safety procedures. The system should be serviced only by authorized repair centers.

IEC Safety Definitions



Hazardous voltage--electrical shock or equipment damage can result if transmitter is connected to live cable. Have qualified utility personnel disconnect both ends of cable before working.



IEC protection class II or double insulated electrical device is one which has been designed in such a way that it does not require a safety connection to electrical ground. In a device of this class, no single failure can result in dangerous voltage becoming exposed so that it might cause an electrical shock. This characteristic must be achieved without relying on a grounded metal casing.

FCC Statement

This device complies with Part 15 of the FCC Rules. Operation is subject to the following two conditions: (1) this device may not cause harmful interference, and (2) this device must accept any interference received, including interference that may cause undesired operation.

Changes or modifications not expressly approved by **The Charles Machine Works, Inc.** could void the user's authority to operate the equipment.

This equipment has been tested and found to comply with the limits for a Class B digital device, pursuant to Part 15 of the FCC Rules. These limits are designed to provide reasonable protection against harmful interference in a residential installation. This equipment generates, uses, and can radiate radio frequency energy and, if not installed and used in accordance with the instructions, may cause harmful interference to radio communications. However, there is no guarantee that interference will not occur in a particular installation. If this equipment does cause harmful interference to radio or television reception, which can be determined by turning the equipment off and on, the user is encouraged to try to correct the interference by one or more of the following measures:

- Reorient or relocate the receiving antenna.
- Increase the separation between the equipment and receiver.
- Connect the equipment into an outlet on a circuit different from that which the receiver is connected.
- Consult the dealer or an experienced radio/TV technician for help.

FCC ID

The Gen-Eye Hot Spot may contain FCC ID: QQQWT41 and IC: 5123A-BGWT41.

About This Manual

This manual contains information for the proper use of this equipment. Cross references such as “See page 50” will direct you to detailed procedures.

Bulleted Lists

Bulleted lists provide helpful or important information or contain procedures that do not have to be performed in a specific order.

Numbered Lists

Numbered lists contain illustration callouts or list steps that must be performed in order.

Foreword

This manual is an important part of your equipment. It provides safety information and operation instructions to help you use and maintain your Gen-Eye Hot Spot equipment.

Read this manual before using your equipment. Keep it with the equipment at all times for future reference. If you sell your equipment, be sure to give this manual to the new owner.

If you need a replacement copy, contact your Gen-Eye Hot Spot dealer. If you need assistance in locating a dealer, call 800-245-6200 or 412-771-6300 or write to the following address:

General Pipe Cleaners
1101 Thompson Avenue
McKees Rocks, PA 15136 USA

The descriptions and specifications in this manual are subject to change without notice. The Charles Machine Works, Inc. reserves the right to improve equipment. Some product improvements may have taken place after this manual was published. For the latest equipment information see your Gen-Eye Hot Spot dealer.

Thank you for buying and using Gen-Eye Hot Spot equipment.

**Gen-Eye™ Hot Spot™
Operator's Manual**









Issue number 1.0/OM-6/13

Part number 053-2672

Copyright 2013

by The Charles Machine Works, Inc.

Contents

	Overview machine serial number, information about the type of work this machine is designed to perform, basic machine components, and how to use this manual	1
	Foreword part number, revision level, and publication date of this manual, and factory contact information	5
	Safety machine safety alerts and emergency procedures	11
	Control Icons control menus and display icon descriptions	15
	Locate procedures for locating active, passive and beacon signals	45
	Service service intervals and instructions for this machine	77
	Specifications machine specifications including weights, measurements and power rating	81
	Support the warranty policy for this machine, and procedures for obtaining warranty consideration and training	63

Safety

Chapter Contents

Guidelines 12

Safety Alert Classifications 13

Safety Alerts 14

Guidelines

Follow these guidelines before operating any jobsite equipment:

- Complete proper training and read operator's manual before using equipment.
- Contact your local One-Call (811 in USA) or the One-Call referral number (888-258-0808 in USA and Canada) to have underground utilities located before working. Also contact any utilities that do not participate in the One-Call service. Classify jobsite based on its hazards and use correct tools and machinery, safety equipment, and work methods for jobsite.
- Mark jobsite clearly and keep spectators away.
- Wear personal protective equipment.
- Review jobsite hazards, safety and emergency procedures, and individual responsibilities with all personnel before work begins.
- Replace missing or damaged safety signs.
- Use equipment carefully. Stop operation and investigate anything that does not look or feel right.
- Contact your equipment dealer if you have any question about operation, maintenance, or equipment use.

Safety Alert Classifications

These classifications and the icons defined on the following pages work together to alert you to situations which could be harmful to you, jobsite bystanders or your equipment. When you see these words and icons in the book or on the unit, carefully read and follow all instructions. **YOUR SAFETY IS AT STAKE.**

Watch for the three safety alert levels: **DANGER**, **WARNING** and **CAUTION**. Learn what each level means.

 **DANGER** indicates an imminently hazardous situation which, if not avoided, will result in death or serious injury.

 **WARNING** indicates a potentially hazardous situation which, if not avoided, could result in death or serious injury.

 **CAUTION** indicates a potentially hazardous situation which, if not avoided, may result in minor or moderate injury.

Watch for two other words: **NOTICE** and **IMPORTANT**.

NOTICE can keep you from doing something that might damage the unit or someone's property. It can also alert you against unsafe practices.

IMPORTANT can help you do a better job or make your job easier in some way.

Safety Alerts

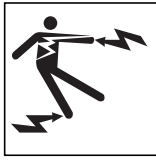

⚠ DANGER

Electric shock. Contacting electric lines will cause death or serious injury. Know location of lines and stay away.

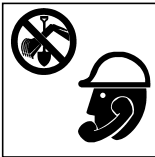

⚠ WARNING

Jobsite hazards could cause death or serious injury. Use correct equipment and work methods. Use and maintain proper safety equipment.

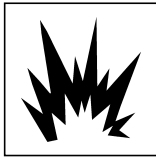

⚠ WARNING

Explosion possible. Serious injury or equipment damage could occur. Follow directions carefully.

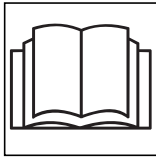

⚠ WARNING

Incorrect procedures could result in death, injury, or property damage. Learn to use equipment correctly.



⚠ WARNING

Moving traffic - hazardous situation. Death or serious injury could result. Avoid moving vehicles, wear high visibility clothing, post appropriate warning signs.



Safety Alert

Read and follow all safety precautions.

Do not operate equipment unless you have completed proper training and have read the operator's manual.

Check that equipment is in good condition and that test leads are clean and have no cracked insulation.



⚠ WARNING HIGH VOLTAGE. This device produces electric current that could cause death or serious injury. Electric shock may result if you touch the clips on the HV output cable. Use electrically insulating rubber gloves and proper procedures.

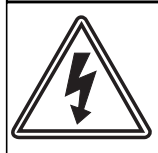

⚠ DANGER Electric shock or equipment damage can result if transmitter is connected to live cable. Have qualified utility personnel disconnect both ends of cable before working.

Turn off transmitter when connecting or moving ground probe.

Jobsite hazards could cause death or serious injury. Use correct equipment and work methods. Use and maintain proper safety equipment.



⚠ WARNING Explosion possible. Do not operate transmitter near explosive devices or blasting operations.



⚠ WARNING Battery cells inside may vent or rupture. Do not crush, do not heat or incinerate, do not short circuit, do not dismantle, do not immerse in any liquid. Observe charging instructions.

Control Icons

Chapter Contents

- Receiver 18**
 - Keypad 18
 - Display 19
 - Menus 20

- Transmitter 21**
 - Keypad 21
 - Display 22
 - Menus 23

Receiver



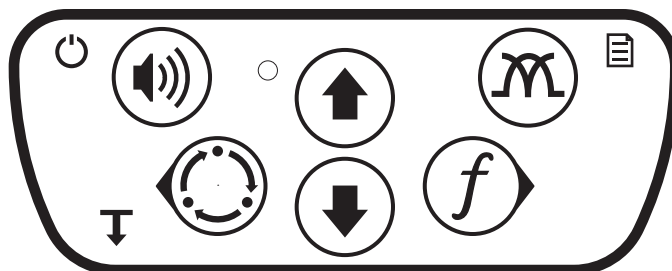







Receiver Keypad



e18om045h.eps

Keypad buttons perform several functions depending on operating mode. To activate most functions, press and release the button. For other functions, press and hold the button until the function activates.

Receiver Keypad Icons

 Power ON/OFF (press and hold)	 Up	 Antenna Configuration
 Volume Exit Menu		 Menu (press and hold)
 Location Mode  Back  Depth (press and hold)	 Down	 Frequency  Select / Next



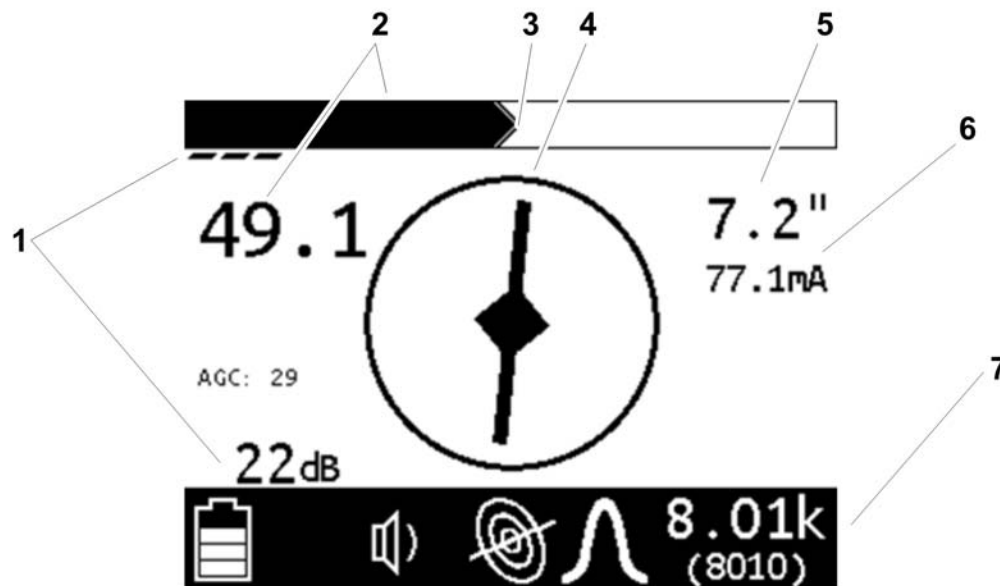





Receiver Display



e18om042h.jpg

















- | | |
|--------------------|--------------------------------|
| 1. Gain | 5. Estimated depth |
| 2. Signal strength | 6. Current meter |
| 3. Peak signal | 7. Unit status bar (see below) |
| 4. Compass | |

Status Bar Icons

 Battery level	 Power mode	 Twin peak antenna
 Volume level	 Beacon mode	 Null antenna
 Line mode	 Total field antenna	 Single peak antenna

Receiver Menus

Menus allow the operator to set user interface preferences. Use the up, down, select/next, and back buttons on the keypad to navigate the menu.

Receiver Menu Icons		
 Frequency	Select frequencies to activate.	Icons show which mode is suited for each frequency:  Power  Beacon  Line
 Settings	 Language	Select user interface language
	 Units	Select measurement units for distance and depth
	 Backlight	Select backlight setting
	 Shutdown Timer	Set amount of time before unit shuts off
 Options	 Gain	Select gain option
	 Autodepth	Select automatic or manual depth
	 Audio Mode	Select audio mode setting
	 Audio Style	Select audio style setting
 System Information	 System Info	Displays the receiver model configuration, model number, serial number, software version, hour count, configuration date, and calibration date.
	 Diagnostics	Use to troubleshoot receiver. Contact Product support.

Transmitter



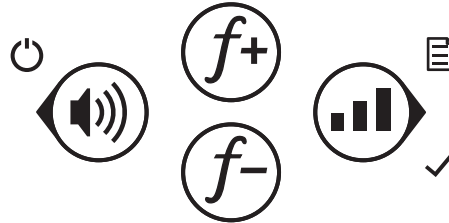



Transmitter Keypad



e18om009h.eps

Keypad buttons perform several functions depending on operating mode. To activate most functions, press and release the button. For other functions, press and hold the button until the function activates.

Transmitter Keypad Icons

	Power ON/OFF (press and hold)	$f+$	Frequency / Up		Power output
	Volume	$f-$	Frequency / Down		Select / Next
	Back				Menu (Press and hold)



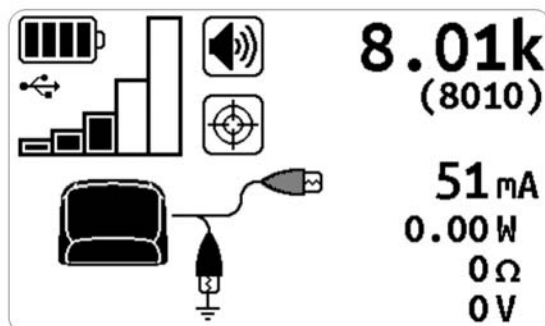







Transmitter Display



e18om044h.jpg













The transmitter display shows the status of selected options as well as the active frequency and meter reading.

Transmitter Display Icons

 Battery level	 Volume on	 Linked to receiver
 USB connected	 Volume off	 Inductive clamp connected
 Output power level	 Output active  Output interrupted	 Induction active  Direct-connect leads connected

Transmitter Menus

Menus allow the operator to set user interface preferences. Use the up, down, select/next, and back keypad buttons to navigate the menu.

Transmitter Menu Icons		
 Settings	 Backlight	Select backlight setting
	 Meter	Select meter setting
 Options	 Language	Select user interface language
	 Defaults	Restores unit to factory default settings.
 Frequencies	Select frequencies to activate.	Icons show which connection can be used for each frequency: <ul style="list-style-type: none">  Induction  Direct connect  Induction clamp, standard  Induction clamp, low frequency
 System Information	Displays the unit model configuration, model number, serial number, software version, hour count, configuration date, and calibration date.	

Locate

Chapter Contents







- Prepare 26**
 - Select Signal Mode 26
 - Select Antenna Configuration 27
 - Select Locating Frequency 27
 - Adjust Receiver Gain 28
- Locate Active Signals 29**
 - Setup 29
 - Technique 32
- Locate Passive Signals 34**
 - Setup 34
 - Technique 34
- Locate Beacon Signals 36**
 - Setup 36
 - Technique 36
- Common Signal Problems 39**



Prepare





Select Signal Mode

Gen-Eye Hot Spot receivers detect active and passive signals. Select the signal best suited for the locating jobsite. Depending on the receiver model, all modes might not be available.

Signal Mode/Type	Description	Notes
Active Signals:	Signal placed on a target line with a transmitter	
 Line signal	 Direct Connection	(preferred method) requires a connection directly to the target line
	 Clamp Induction	requires placing an optional induction clamp around the target line
	 Broadcast induction	sends current into lines near the transmitter
 Beacon signal	Signal transmitted from a beacon inside a pipe or conduit	
Passive Signals:	Signal that a utility line picks up from the environment	
 Power Signal	Allows receiver to trace live 50 Hz or 60 Hz power cables	IMPORTANT: Current must be flowing through the cable.
 Radio Signal	Allows receiver to trace cables that pick up and radiate very low frequency (VLF) radio waves	

Select Antenna Configuration

Select the antenna configuration best suited for the locating jobsite.

Antenna	Description	Advantage / Disadvantage
 Single Peak	Uses one horizontal antenna to detect signal. Response is highest at strongest signal.	more range / less precise
 Twin Peak	Uses two horizontal antenna to detect signal. Response is highest at strongest signal.	most precise / less range
 Null point	Uses a vertical antenna to detect signal. Search width is narrower than single peak. Response is lowest when receiver is over the line.	sharp response / easily distorted in congested areas
 Total Field	Uses a combination of two horizontal and one vertical antenna to locate signal.	easy to use when sweeping and eliminates ghost signals / easily distorted in congested areas



Select Frequency

The Gen-Eye Hot Spot transmitter can send signals in 4 frequencies at 5 watt power levels. Likewise, the receiver can display information in over 70 frequencies. Optimal frequencies for your area can be configured for each unit using software. Then, use the transmitter and receiver frequency menus to activate only the frequencies most suited for a particular jobsite. Be aware of these points:

- Lower frequencies travel farther than higher frequencies.
- Higher frequencies couple onto lines more easily.
- Higher frequencies also couple onto lines other than the target line more easily.

Activate Frequencies

To activate frequencies on the transmitter as well as the receiver:

1. Navigate to **Settings>Frequency** menu.
2. Select the frequencies best suited for the jobsite conditions. When the box is checked, the frequency is active.

Note: Power, line, and beacon icons indicate which mode a frequency is suited for.

3. While locating, press the **Frequency** button to toggle between activated frequencies.

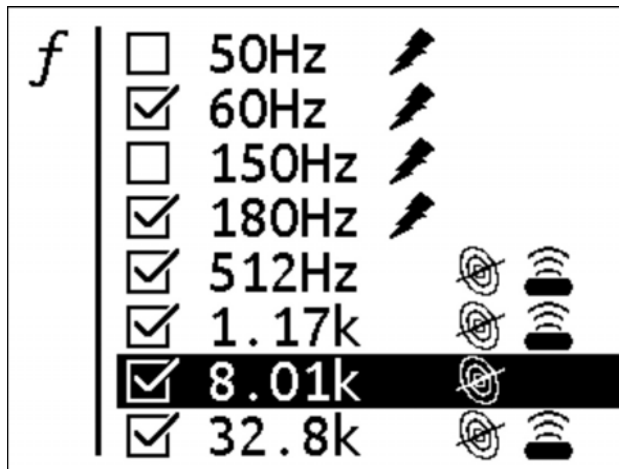

e18om046h.jpg

Adjust Receiver Gain

The receiver gain setting controls the sensitivity to the signal.

Action	Result	Effect
increasing gain	more sensitive to signal	allows location farther away from signal source
decreasing gain	less sensitive to signal	stabilizes signal

Locate Active Signals

Setup

Follow setup procedures for the type of locating you will be doing: direct connection, induction clamp, or broadcast. For all types of active location that require leads, connect leads to transmitter at connector (2). Keep connector covered when not in use. When it is necessary to connect to external power, use connector (1).

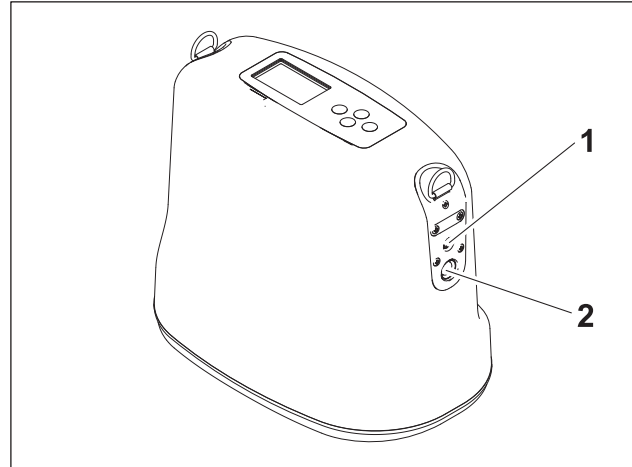

e18om016h.eps

Induction Clamp



WARNING

Jobsite hazards could cause death or serious injury. Use correct equipment and work methods. Use and maintain proper safety equipment.

NOTICE: Electric shock or equipment damage can result if transmitter is connected to live cable. Contact qualified utility personnel and follow all standards and requirements for disconnecting and grounding cables.

To set up transmitter for use with induction clamp:

1. Plug cable into transmitter.
2. Place clamp around cable.
3. Turn on transmitter.
4. Check battery level.

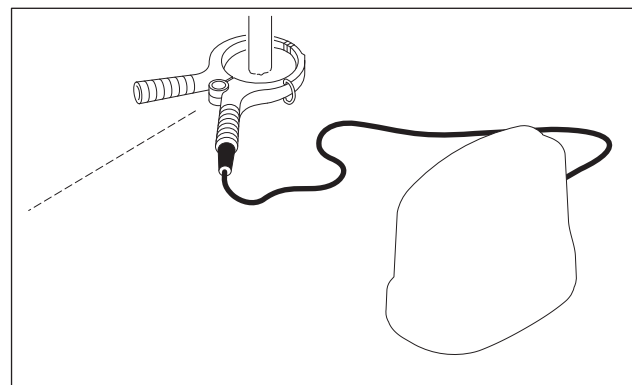

e18om022h.eps

Direct Connection



WARNING Jobsite hazards could cause death or serious injury. Use correct equipment and work methods. Use and maintain proper safety equipment.

NOTICE:

- Electric shock or equipment damage can result if transmitter is connected to live cable. Contact qualified utility personnel and follow all standards and requirements for disconnecting and grounding cables.
- A built-in circuit breaker will automatically disable transmitter when leads are connected to a live cable. Display will flash and transmitter will beep. Turn off transmitter and disconnect from cable to reset breaker.

To set up transmitter for direct connection:

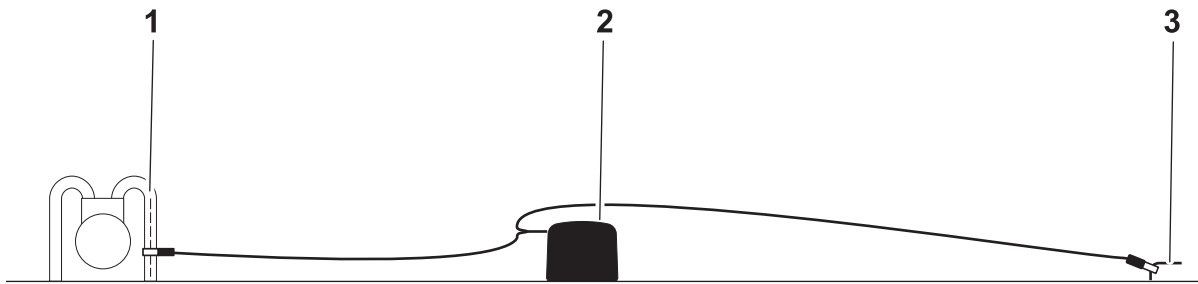

e18om028h.eps

1. Carefully push ground stake (3) into ground.
2. Plug cable into transmitter (2).
3. Connect black lead to ground stake.
4. Connect red lead to cable (1).

Note: If using dual location, connect white lead to the additional cable to be located.

5. Turn on transmitter and check battery level.

NOTICE: Turn off transmitter when connecting or moving ground stake.

Induction

To set up transmitter for induction:

1. Remove cable, stake, clamp and any other metal objects from transmitter.
2. Place transmitter parallel to and directly above suspected cable as shown.

Note: Transmitter must be parallel to object, as shown, in order to produce the best signal.

3. Turn on transmitter.
4. Check battery level.

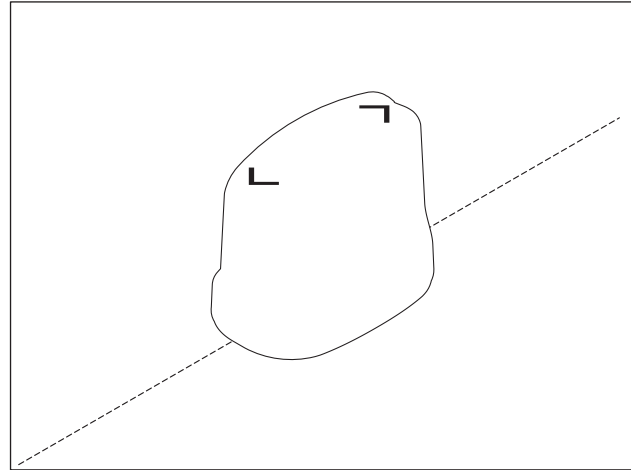

e18om025h.eps



Technique

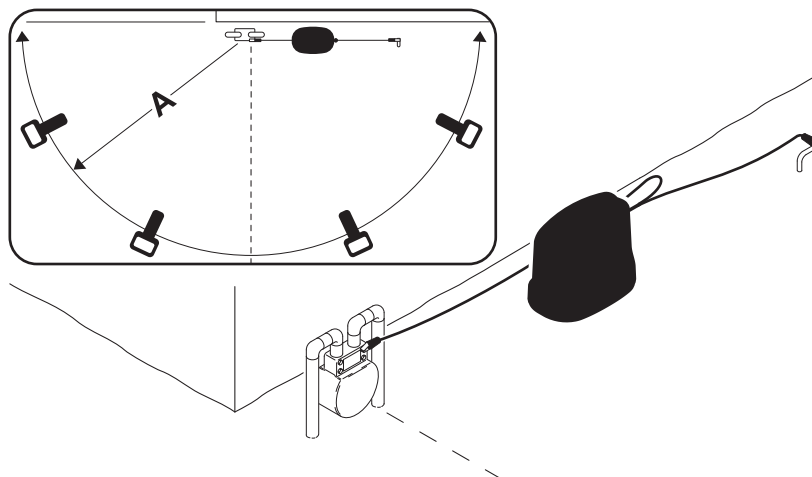

e18om021h.eps

IMPORTANT: Follow steps below for all types of active location. For reference, the illustration above shows direct connection method. If using broadcast induction, ensure that transmitter is in line with and above suspected cable, as shown on previous page.

1. Facing away from the transmitter, walk in an arc approximately 25' (A, 7.5 m) around transmitter, as shown above.

2. Rotate the receiver and observe the screen:

- Target is located where signal response (1) is strongest. Signal strength is shown graphically as well as numerically.
- Adjust gain as needed to maintain signal strength. Gain is shown graphically as well as numerically (6).
- The Compass Line (2) shows the direction the cable runs.
- Move in the direction of the center arrows. When the arrows form a diamond (3), the target is located.
- AutoDepth reading (4) will appear when target is correctly located. If operating in Manual depth mode, press and hold the **Depth** button.

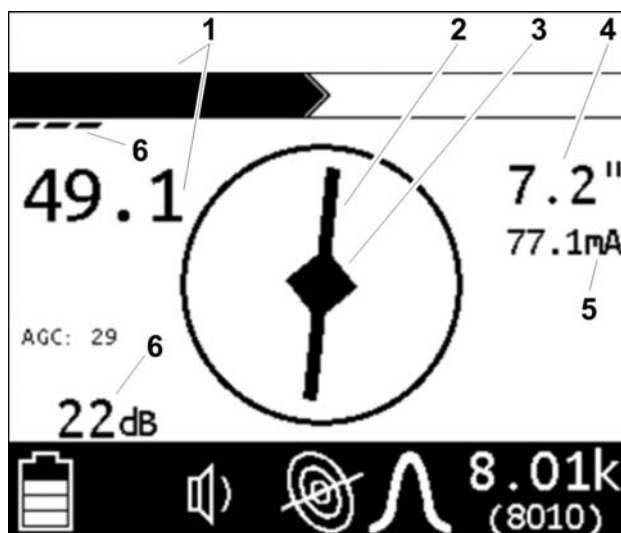

e18om043h.jpg

- Use Current Measurement (5) to identify target cable. Current on the target cable should be higher than current on another cable that is picking up signal inductively from target cable.

3. Continue to trace the cable and observe depth estimates every few paces.

4. Retrace the cable and mark with appropriate flags or paint.

Mark the Cable

Sweep, focus, and trace all detected signals in the area. Mark cable paths with colored paint or flags. See the chart below for standard color markings for cable locations.

Utility	Color	Marking Symbol
electric	red	-E-
gas/oil	yellow	-G-
communications	orange	-TEL- or -TV-
water	blue	-W-
sewer	green	-S-



Special Situations

Situation	What to try
Signal is lost.	Walk in a circle to detect a tee or bend in the cable.
Signal varies from low to high and is unstable.	Mark as a hand-dig area.
You are near a power line and are receiving interference.	Sweep the area in 50 Hz or 60 Hz power mode. If receiver gives a strong signal response, a power line is interfering with transmitter signal.
Receiver does not function properly.	Receiver gain could be set too high or low. Lower or raise gain to locate the cable.
Target cable has connections to other cables.	Disconnect target cable from other cables or use direct connect or induction clamp to focus signal on target cable.
Signal is transferring to other cables.	<ul style="list-style-type: none"> • Lower the frequency. • Lower the power level. • Use direct connection, if possible, or use induction clamp. • Move the ground stake away from the target cable and away from other buried cables. • Apply signal at the point where the target cable is farthest from the other cables.

Locate Passive Signal

Setup

Follow setup procedures for the type of locating you will be doing. Always check receiver battery level at startup.

NOTICE: Cables with no A/C current flowing through them are hard to detect and may be hazardous because they may still have voltage potential. To locate, turn on an appliance to cause current to flow and use active search methods.

Technique

Survey the Site

Make a visual check of the site for signs of buried cables such as:

- recent trenching
- buried cable markers
- overhead lines that run down pole and underground
- gas meters
- valve sights
- drains or manhole covers

Sweep the Site

Search the site by walking a grid pattern while holding receiver close to the ground.

NOTICE: Keep receiver vertical.

Focus the Signal

Move receiver over detected signal to find best signal response. If using a peak antenna mode, rotate receiver until signal is best. Best signal indicates cable direction.

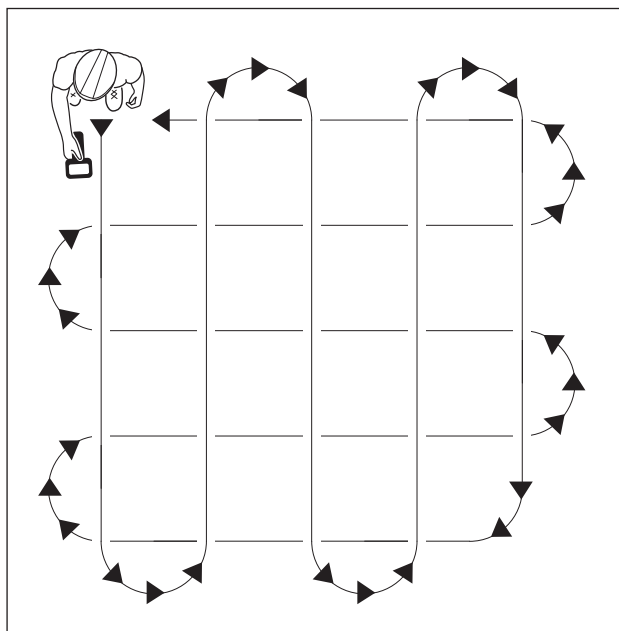

ss1076a-d.eps

Trace the Cable

Walk along the suspected path while moving the receiver from side to side across the area.

IMPORTANT: Keep receiver handle parallel to the suspected cable path.

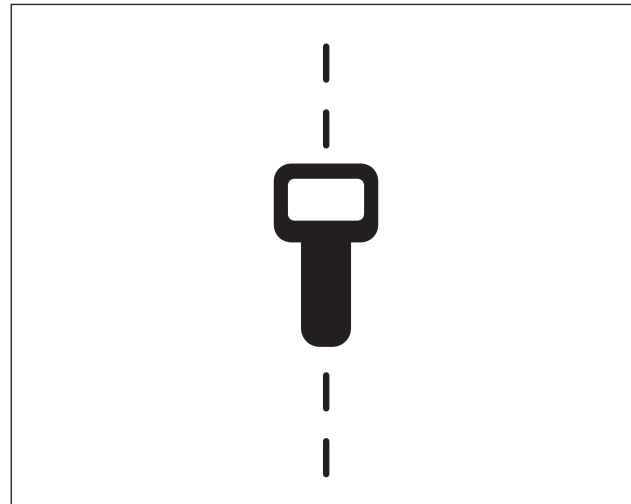

ss1080a-d.eps



Mark the Cable

Sweep, focus, and trace all detected signals in the area. Mark cable paths with colored paint or flags. See the chart below for standard color markings for cable locations.

Utility	Color	Marking Symbol
electric	red	-E-
communications	orange	-TEL- or -TV-

Special Situations

Situation	What to try
Signal is lost.	Walk in a circle to detect a tee or bend in the cable.
Signal varies from low to high and is unstable.	Mark as a hand-dig area.
Receiver does not function properly.	Receiver gain could be set too high or low. Lower or raise gain to locate the cable.

Locate Beacon Signal

Trace metallic pipes or conduits by locating and following a beacon signal.

IMPORTANT: Large metal objects and other signals (such as railroad signals or overhead power lines) will distort signal.

Setup

1. Follow instructions for installing beacon battery.
2. Turn on receiver to ensure that beacon is functioning properly.
3. Attach beacon to plumber's snake or flex rod.

Technique

1. Turn on receiver.
2. Set operating mode to Beacon location.
3. Set antenna configuration to Total Field.
4. Place beacon into the pipe and move it down the pipe.

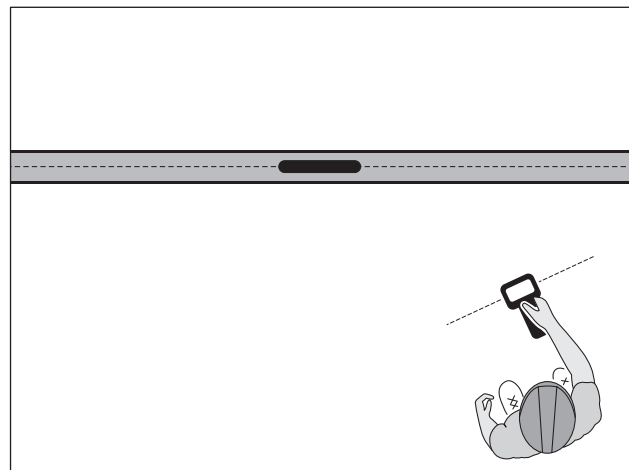

e18om031h.eps

5. Locate beacon:

Null Point Method: Circle over approximate location. Follow directional arrows (1, 3) to locate the null point (2). The beacon is correctly located at peak signal between null points.

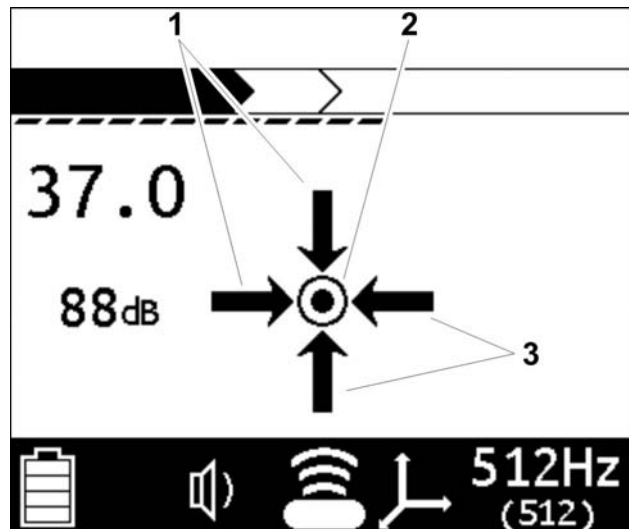

e18om047h.jpg

Peak Signal Method: When the peak signal is in range, rotation arrows will appear. Follow arrows (2) to rotate the receiver so that it is perpendicular to the beacon.

Follow fore/aft arrow (1) to locate the strongest signal response.

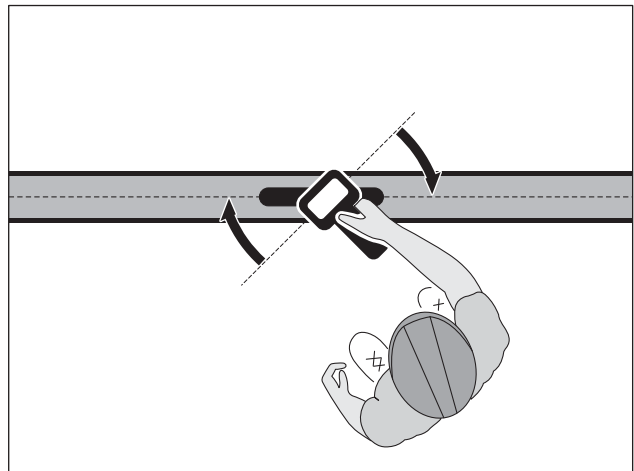

e18om032h.eps

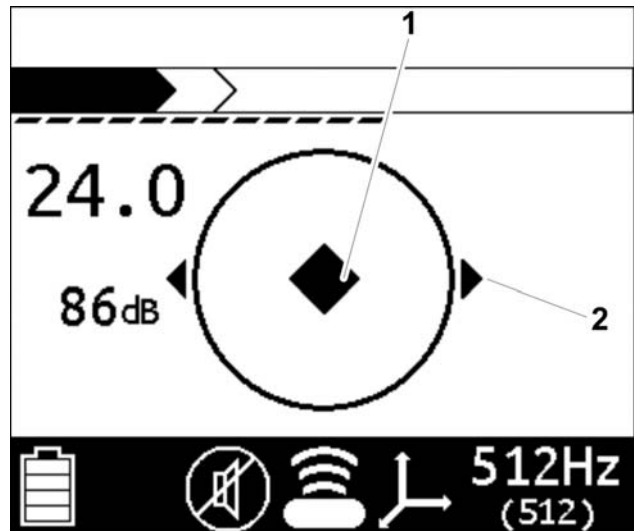

e18om048h.jpg

6. When the beacon is correctly located, a diamond (1) will form in the center of the compass, the exterior arrows (2) will appear, and the depth reading will display.
7. If operating in Manual depth, press the **Depth** key to estimate depth.

NOTICE: When estimating depth with a beacon in nonmetallic pipe, depth shown will be to the center of the beacon, not to the top of the pipe.

8. Continue to track the beacon and observe depth readings. Mark pipe location with paint.

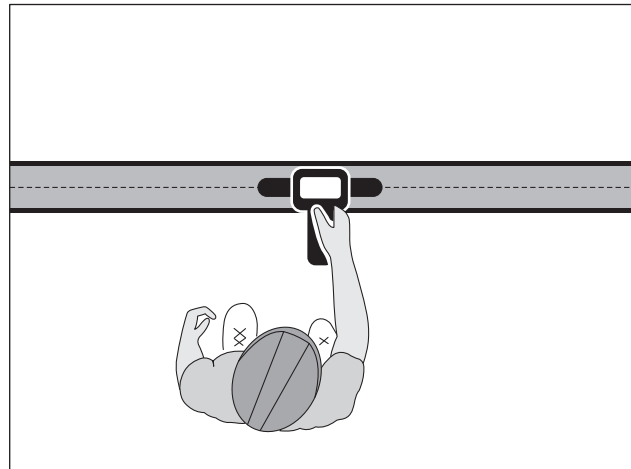

e18om033h.eps

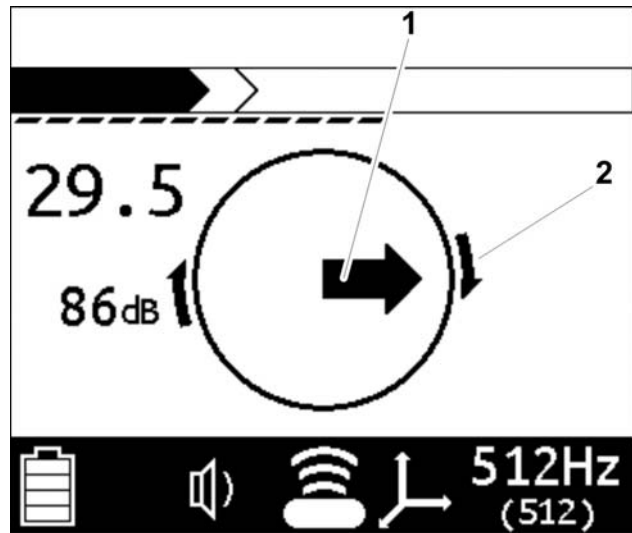

e18om049h.jpg

Common Signal Problems

Distortions in the electromagnetic field around a cable can affect location accuracy. Tees, bends, parallel cables, crossing cables, or large metallic objects can distort signals.

IMPORTANT: If target depth and location are critical, confirm by hand-digging or vacuum excavation.

Learn to recognize the following kinds of distortion:

Shadows

Shadows, also called blind spots, often happen when a metallic object partially obstructs the signal, or a signal from a parallel cable interferes with target signal.



Secondary (Ghost) Signals

A typical beacon signal pattern shows a main signal and two weaker secondary signals. Identify beacon location at the main signal. Familiarity with beacon signal patterns will lessen the effect of ghost signals. Using the Total Field antenna mode will eliminate ghost signals. See "Select Antenna Configuration" on page 27.

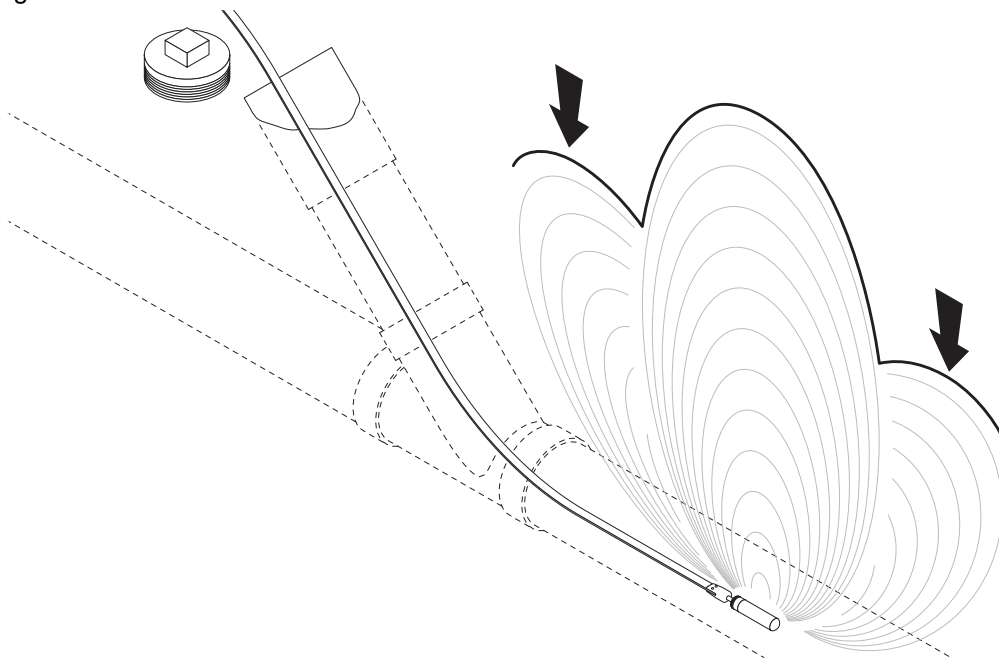

e180m039h.eps

Service

Chapter Contents

General Care 46

As Needed 46

General Care

Under normal operating conditions, receiver, transmitter and A-frame detector need only minor maintenance. Following these care instructions can ensure longer equipment life:

- Do not drop the equipment.
- Do not expose the equipment to high heat (such as in the rear window of a vehicle).
- Clean equipment with a damp cloth and mild soap. Never use scouring powder.
- Do not immerse in any liquid.
- Inspect housing daily for cracks or other damage. If housing is damaged, contact your equipment dealer for replacement.
- Do not mix new and used batteries.

As Needed

Location	Task	Notes
Receiver Unit	Change batteries	2 "D" alkaline
Transmitter Unit	Change batteries	10 "D" alkaline

Receiver Unit

Change Batteries

Use 2 D-cell alkaline batteries in receiver.

1. Remove battery cover.
2. Insert batteries as shown.
3. Install and tighten battery cover.
4. Check operation.

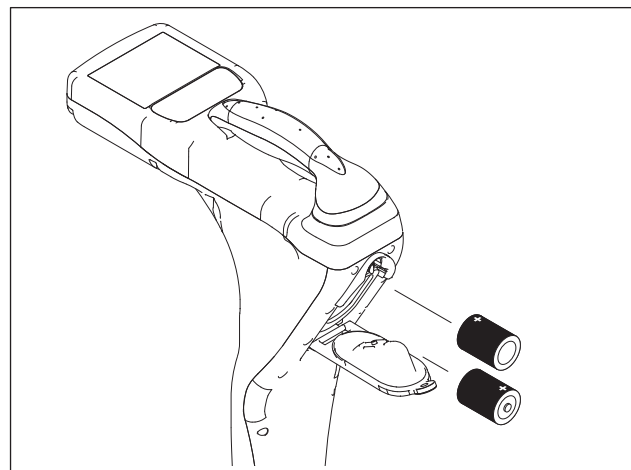

e18om003h.eps

Transmitter Unit

Change Batteries

Use ten D-cell alkaline batteries or a Lithium-ion battery pack in transmitter.



WARNING Battery cells inside may vent or rupture. Do not crush, do not heat or incinerate, do not short circuit, do not dismantle, do not immerse in any liquid. Observe charging instructions.

To help avoid injury, see battery manufacturer's safety instructions.

1. Open battery cover.
2. Insert batteries as shown.

IMPORTANT:

- Installing batteries backwards will cause damage to batteries and unit.
- Ensure that door is closed tightly.
- Do not mix new and used batteries.

3. Close and tighten battery cover.
4. Check operation. If battery light is flashing when unit is turned on, then one battery is incorrectly installed or batteries are weak.

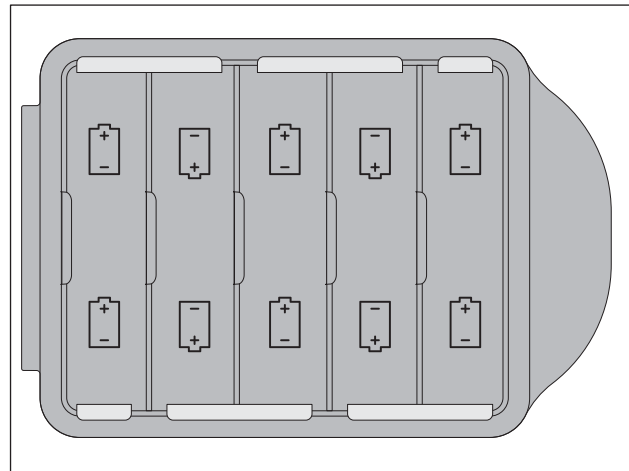

e18om008h.eps

Update Software

The manufacturer updates software periodically to fix bugs and improve functionality. These updates are accessible through web-based software available with this product.

To install updates:

1. Use a USB cable to connect the unit to a personal computer.
2. Launch the software and follow prompts to install updates.

Refer to the software application for more information.

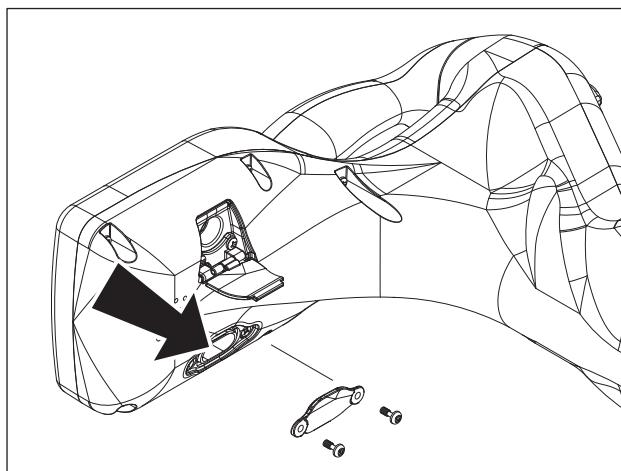

e18om015h.eps

Specifications

Receivers

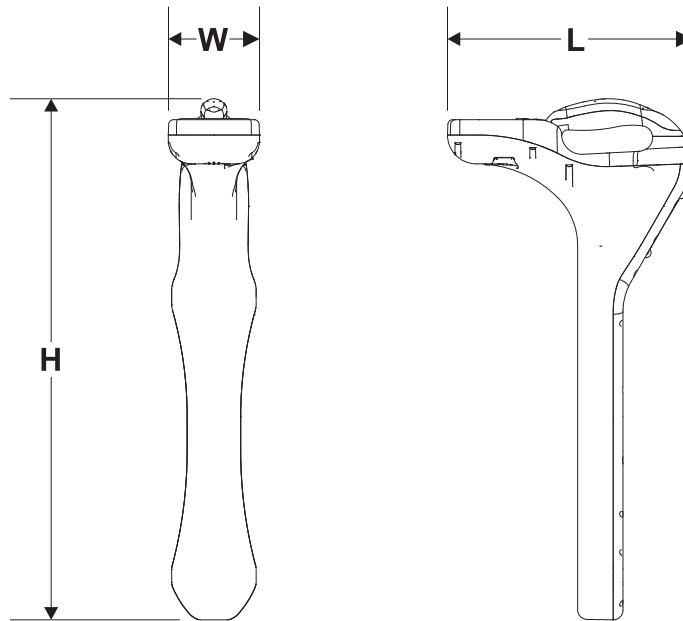

e18om001h.eps

Dimensions		U.S.	Metric
H	Height	27.2"	69.09 cm
L	Length	12.8 "	32.50 cm
W	Width	4.8"	12.19 cm
	Weight	4.8 lb	2.18 kg
Operation		U.S.	Metric
Operating temperature range		-4°F to 122°F	-20°C to 50°C

Antenna configurations: single peak, twin peak, null, left/right (cable only)

Audio output: speaker

LCD backlight: LED

External ports: Mini USB

Batteries

Type: 2 D-cell alkaline

Life (intermittent use at 70°F/21°C): approximately 30 hours

Battery saver: unit shuts off after 5 minutes of inactivity

Transmitters

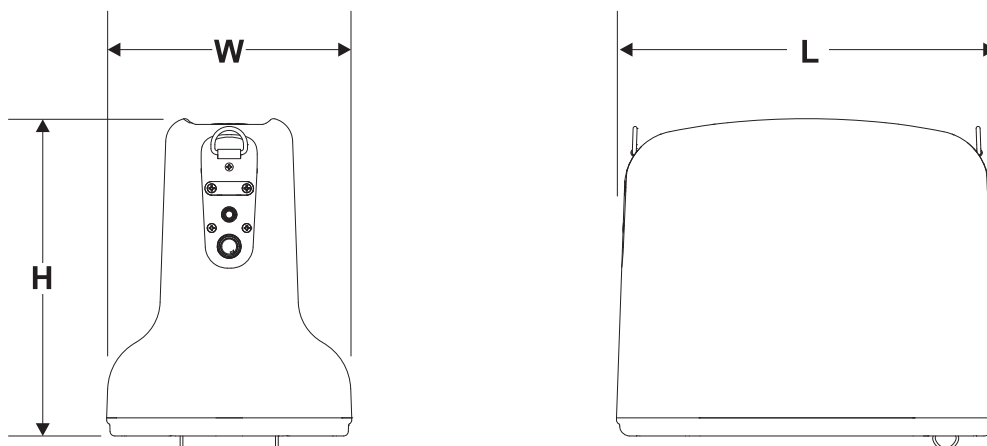

e18om002h.eps

Dimensions		U.S.	Metric
H	Height	10"	25.40 cm
L	Length	12"	30.48 cm
W	Width	7.8"	19.1 cm
	Weight	7.8 lb	3.54 kg
Operation		U.S.	Metric
Operating temperature range		-4°F to 122°F	-20°C to 50°C
Maximum power output: 5 watts			
Standard operating frequency: 1 kHz, 8 kHz, 33 kHz, 65 kHz			
Timer: unit runs continuously or shuts off after running for a selected hour interval (8-hour maximum).			
Batteries			
Type: 10 D-cell alkaline or 1 Lithium ion battery pack (p/n 220-2221)			
Life (continuous use at power level 2): Alkaline - approximately 100 hours; Lithium ion approximately 80 hours.			

System Operation

Operating Modes and Frequencies

Active cable, standard: 6 active frequencies

Passive cable, standard: 60 Hz, 120 Hz, 180 Hz, 50 Hz, 100 Hz, 150 Hz

Beacon (locate/depth only): 512 kHz and 33 kHz

Locating Ranges	U.S.	Metric
Cables	15'	4.6 m
Beacons	10'	3 m

Depth Estimate Tolerances*	U.S.	Metric
Passive cable $\pm 10\%$	0.5-10'	0.15-3 m
Active cable $\pm 5\%$	0.2-10'	0.2-3 m
Beacon $\pm 5\%$	0.5-10'	0.15-3 m

* Locators are calibrated to these tolerances under ideal test field conditions. Actual operating field conditions may have signal distortions or may contain noise sources which result in depth range that is less than specified.

Support



Procedure

Notify your dealer immediately of any malfunction or failure of Gen-Eye equipment.

Always give model, serial number, and approximate date of your equipment purchase. This information should be recorded and placed on file by the owner at the time of purchase.

Return damaged unit to dealer for inspection and warranty consideration if in warranty time frame.

All repairs must be done by an authorized repair facility. Repairs done elsewhere will void warranty.

Resources

Publications

Contact your Gen-Eye Hot Spot dealer for publications and videos covering safety, operation, service, and repair of your equipment.

Training

For information about on-site, individualized training, contact your Gen-Eye Hot Spot dealer.

Warranty

Electronics Limited Warranty Policy

Subject to the limitation and exclusions herein, free replacement parts and labor will be provided when a unit fails due to a defect in material or workmanship within one (1) year of first commercial use (See Exceptions below for specific products). Defects shall be determined through inspection by Manufacturer or authorized repair centers. An inspection must occur within thirty (30) days of the date of failure of the product or part by Manufacturer or its authorized repair facility. Manufacturer will provide the location of its inspection facilities or its nearest authorized dealer upon inquiry. Manufacturer reserves the right to supply remanufactured replacement parts under this warranty as it deems appropriate. Each warranty repair carries the remainder of the factory warranty or 90 days, whichever is longer, for all repaired components and labor.

Product Warranty Exceptions:

- All Locate Beacons and Accessories carry a six (6) month warranty.
- All Used (Cosmetic) Electronics products sold from Manufacturer carry a six (6) month warranty from date of sale to dealer.

EXCLUSIONS FROM PRODUCT WARRANTY

- All defects or damages caused by misuse, abuse, improper installation, alteration, neglect, modification, lack of maintenance, or uses other than those for which products were intended.
- All defects, damages, or injuries caused by improper training, operation, or servicing of products in a manner inconsistent with manufacturer's recommendations.
- All batteries, which are considered consumable and therefore not covered under this warranty.
- All damaged plastics are considered to be the result of misuse or neglect unless Manufacturer has determined otherwise.
- All repairs or attempted repairs by non-certified repair facilities or personnel will void the warranty.
- All incoming duties and freight charges.

(Exclusions from Product Warranty, continued)



- Manufacturer reserves the right to make changes in design and/or improvements to products from time to time, and user understands that Manufacturer shall have no obligation to upgrade any previously manufactured product to include any such changes.
- In no event shall Manufacturer or its agents, assigns or parent company be liable for any indirect, special, incidental, or consequential damages or for any cover, loss of information, profit, revenue or use based upon any claim by user for breach of warranty, breach of contract, negligence, strict liability or any other legal theory. In no event shall Manufacturer liability exceed the amount user has paid for the Manufacturer product.
- Manufacturer will not be responsible for loss of accessories or loss or erasure of data storage media.
- Should it be determined that applicable law prohibits enforcement of any provision of this Warranty Policy, then to the extent it is necessary to comply with the applicable law, this Warranty Policy shall be deemed amended.
- This Warranty Policy shall be the entire agreement between Manufacturer and the Purchaser. Any statements that purport to be different than or modify or expand the terms set forth in this written policy are not effective for any purpose. ANY IMPLIED WARRANTIES, INCLUDING WARRANTIES OF MERCHANTABILITY AND FITNESS FOR A PARTICULAR USE ARE EXPRESSLY DISCLAIMED. IN NO EVENT SHALL GENERAL PIPE CLEANERS, THE CHARLES MACHINE WORKS, INC., OR ANY AUTHORIZED SERVICING AUTHORITY BE RESPONSIBLE FOR ANY LOSSES, INCLUDING CONSEQUENTIAL AND INCIDENTAL DAMAGES, EXCEPT AS EXPRESSLY PROVIDED HEREIN.

SERVICE AND REPAIR

All units repaired at Manufacturer's location or an authorized service center will carry a 90 day warranty on all replaced components/parts and labor commencing on the date of repair.

EXTENDED WARRANTY

Consult your local Gen-Eye Hot Spot dealer for extended warranty options.

WARRANTY DETAILS

For information regarding this limited warranty, contact General Pipe Cleaners, 1101 Thompson Avenue, McKees Rocks, PA 15136 USA, 800-245-6200, 412-771-6300, or your local dealer.

March 2013

